

BRONZE SCREW-OVER BONNET GATE VALVES

I.P.S. AND
CxC

MODEL
T-414



MODEL
S-414



LEGEND MODEL T-414/S-414 gate valves are constructed of heavy duty bronze. They have a screw-over bonnet, non-rising stem, solid wedge disc and integral seats. The disc is fully guided on both sides for precise alignment. Recommended for commercial and industrial use on steam, water, oil or gas. May be repacked while in service under pressure.

MATERIAL SPECIFICATION	
PART	MATERIAL
BODY	BRONZE
BONNET	BRONZE
STEM	BRASS
PACKING NUT	BRASS
DISC	BRONZE
HAND WHEEL	CAST IRON
WHEEL NUT	BRASS
LOCK NUT	BRASS
GLAND	BRASS
PACKING	TEFLON*

PRESSURE RATING
200 W.O.G. NON-SHOCK
125 W.S.P.

*DUPONT REG T.M.

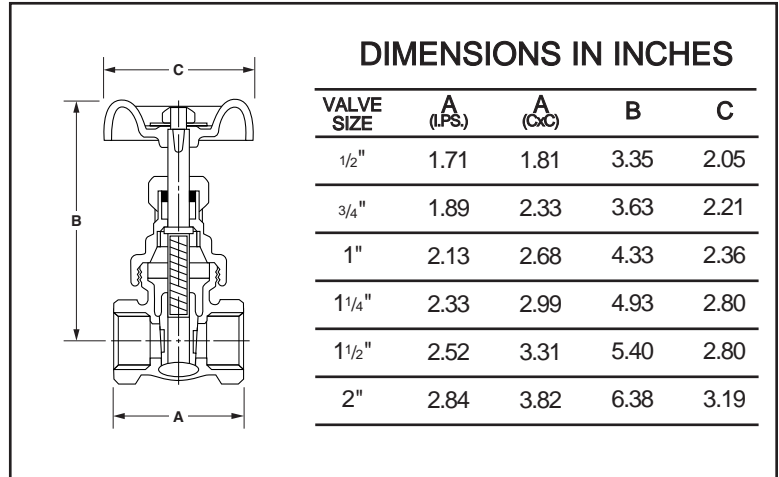

BRONZE INSERTED BONNET GATE VALVES

ISO-9002
I.P.S. AND CxC

MODEL
T-415



MODEL
S-415



LEGEND MODELS T-415/S-415 bronze gate valves have a screwed bonnet, non-rising stem, solid wedge disc, and integral seats. The body, bonnet, and disc are manufactured from heavy duty bronze. The aluminum hand wheel has an easy grip configuration. Each valve is tested twice: air under water, in the open and closed position. Recommended for commercial and industrial use on steam, water, oil or gas. May be repacked while in service under pressure.

MATERIAL SPECIFICATION	
PART	MATERIAL
BODY	BRONZE
BONNET	BRONZE
STEM	BRASS
DISC	BRONZE
PACKING NUT	BRASS
HAND WHEEL	ALUMINUM
WHEEL NUT	BRASS
LOCK NUT	BRASS
GLAND	BRASS
GLAND PACKING	GRAPHITE/TEFLON

PRESSURE RATING
200 W.O.G. NON-SHOCK
125 W.S.P.

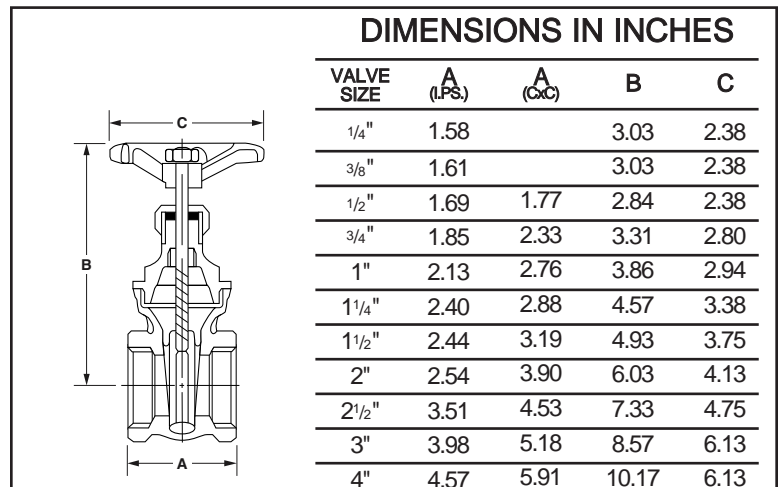

BRASS GATE VALVES

I.P.S. AND CxC

ISO-9002

**MODEL
T-401**



**MODEL
S-401**



MATERIAL SPECIFICATION	
PART	MATERIAL
BODY	BRASS
BONNET	BRASS
STEM	BRASS
PACKING NUT	BRASS
DISC	BRASS
HAND WHEEL	CAST IRON
WHEEL NUT	BRASS
LOCK NUT	BRASS
GLAND	BRASS
PACKING	ASBESTOS FREE GRAPHITE

PRESSURE RATING
200 W.O.G.
NON-SHOCK to 200 F

LEGEND MODELS T-401/S-401 gate valves are constructed of heavy duty cast brass. Body and bonnet are connected with a tight metal to metal leakproof seat. The T401/S-401 have a screwed bonnet, non-rising stem, solid wedge disc, and integral seats. Recommended for non-steam use in residential and commercial applications. May be repacked while in service under pressure.

The T-401/S-401 is the finest valve in its class on the market.

DIMENSIONS IN INCHES				
VALVE SIZE	A (I.P.S.)	A (CxC)	B	C
1/4"	1.62		3.27	2.13
3/8"	1.62		3.29	2.13
1/2"	1.69	1.77	3.52	2.13
3/4"	1.85	2.33	4.02	2.13
1"	2.13	2.76	4.57	2.40
1 1/4"	2.40	2.88	5.38	2.96
1 1/2"	2.44	3.19	6.03	2.96
2"	2.84	3.90	7.50	3.19
2 1/2"	3.51	4.53	9.25	4.14
3"	3.98	5.18	10.75	4.45
4"	4.57		12.60	5.20

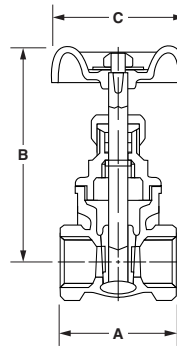

BRASS GATE VALVES

COMPACT PATTERN
I.P.S. AND CxC

ISO-9002

**MODEL
T-400**



**MODEL
S-400**



MATERIAL SPECIFICATION	
PART	MATERIAL
BODY	BRASS
BONNET	BRASS
STEM	BRASS
PACKING NUT	BRASS
DISC	BRASS
HAND WHEEL	CAST IRON
WHEEL NUT	BRASS
LOCK NUT	BRASS
GLAND	BRASS
PACKING	ASBESTOS FREE GRAPHITE

PRESSURE RATING
200 W.O.G.
NON-SHOCK to 200 F

LEGEND MODELS T-400/S-400 gate valves are constructed of cast brass. Body and bonnet are connected with a tight metal to metal leakproof seat. They have a screwed bonnet, non-rising stem, solid wedge disc and integral seats. Recommended for non-steam use in residential and commercial applications. They are an excellent competitive alternative where port size is not critical.

DIMENSIONS IN INCHES				
VALVE SIZE	A (I.P.S.)	A (CxC)	B	C
1/2"	1.54	1.62	2.72	2.13
3/4"	1.73	2.13	2.92	2.13
1"	1.85	2.48	3.31	2.13
1 1/4"	2.09	2.64	3.86	2.40
1 1/2"	2.25	2.96	4.57	2.96
2"	2.40	3.51	4.93	2.96
2 1/2"	2.80		6.03	3.19
3"	3.43		7.33	4.14
4"	3.96		8.67	4.41

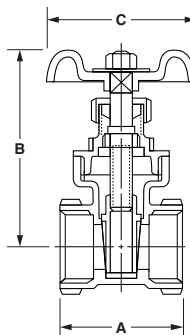

BRASS GATE VALVES

CAST BRASS ECONOMY VERSION
I.P.S. AND CXC



MODEL T-408



MODEL S-408

PRESSURE RATING
200 W.O.G.
NON-SHOCK to 200 F

MATERIAL SPECIFICATION	
PART	MATERIAL
BODY	BRASS
BONNET	BRASS
STEM	BRASS
PACKING NUT	BRASS
DISC	BRASS
HAND WHEEL	CAST IRON
WHEEL NUT	BRASS
LOCK NUT	BRASS
GLAND	BRASS
PACKING	ASBESTOS FREE GRAPHITE

LEGEND MODELS T-408/S-408 gate valves are constructed of heavy duty cast brass. Body and bonnet are connected with a tight metal to metal leakproof seat. They have a screwed bonnet, non-rising stem, solid wedge disc, and integral seats. Recommended for non-steam use in residential applications. The T-408/S-408 is Legend's newest entry into the competitive gate valve market.

DIMENSIONS IN INCHES				
VALVE SIZE	A (I.P.S.)	A (CXC)	B	C
1/2"	1.71	1.69	2.92	2.01
3/4"	1.81	2.33	3.31	2.21
1"	2.13	2.72	3.90	2.56
1 1/4"	2.24	2.94	4.61	2.76
1 1/2"	2.44	3.29	5.08	3.11
2"	2.68	3.98	5.99	3.70
2 1/2"	3.70		6.90	4.02
3"	4.02		8.47	5.00
4"	4.53		9.89	5.00

COMPRESSION END GATE VALVE

CAST BRASS



MODEL T-402

PRESSURE RATING
200 W.O.G.
NON-SHOCK to 200 F

MATERIAL SPECIFICATION	
PART	MATERIAL
BODY	BRASS
BONNET	BRASS
STEM	BRASS
PACKING NUT	BRASS
DISC	BRASS
HAND WHEEL	CAST IRON
GLAND	BRASS
PACKING	ASBESTOS FREE GRAPHITE
COMPRESSION RING	BRASS TUBE
NUT	BRASS

LEGEND MODEL T-402 gate valves are the same construction as the T-401/S-401 but with labor saving compression ends. They have a screwed bonnet, non-rising stem, solid wedge disc, and integral seats. Recommended for non-steam use in residential and light commercial applications. May be repacked while in service under pressure.

Excellent for use as a repair valve.

DIMENSIONS IN INCHES			
VALVE SIZE	A	B	C
1/2"	2.52	3.39	2.13
3/4"	2.76	4.00	2.13
1"	3.15	4.45	2.40

DRAINABLE GATE VALVE

CAST BRASS
I.P.S. AND CxC



MODEL
T-403



MODEL
S-403

LEGEND MODEL T-403/S-403 gate valves are the same construction as the T-401/S-401 but with a drain cap which allows the line to be drained to prevent freeze up. They have a screwed bonnet, non-rising stem, solid wedge disc, and integral seats. Recommended for non-steam use in residential and light commercial applications. May be repacked while in service under pressure.

MATERIAL SPECIFICATION	
PART	MATERIAL
BODY	BRASS
BONNET	BRASS
STEM	BRASS
PACKING NUT	BRASS
DISC	BRASS
HAND WHEEL	CAST IRON
GLAND	BRASS
PACKING	ASBESTOS FREE GRAPHITE
DRAIN CAP	BRASS
DRAIN PACKING	NYLON

PRESSURE RATING
200 W.O.G.
NON-SHOCK to 200 F

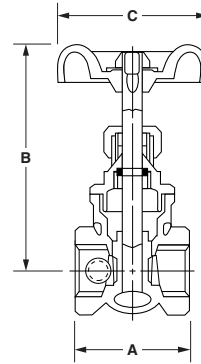

DIMENSIONS IN INCHES

VALVE SIZE	A (I.P.S.)	A (CxC)	B	C
1/2"	1.69	1.77	3.42	2.13
3/4"	1.85	2.33	3.85	2.13
1"	2.21	2.84	4.64	2.40

CPVC CONNECTION GATE VALVE

CAST BRONZE



MODEL
T-404

LEGEND MODEL T-404 gate valves are constructed of heavy duty bronze. Body and bonnet are connected with a tight metal to metal leakproof seat. They come equipped with CPVC transition fittings for connection to CPVC copper tube size pipe. They have a screwed bonnet non-rising stem, solid wedge disc and integral seat. Recommended for residential application.

MATERIAL SPECIFICATION	
PART	MATERIAL
BODY	CAST BRONZE
BONNET	CAST BRONZE
STEM	BRASS
PACKING NUT	BRASS
DISC	BRONZE
HAND WHEEL	CAST IRON
GLAND NUT	BRASS
PACKING	TEFLON*
CPVC WASHERS	NBR (BUNA-N)
END NUTS	BRASS

PRESSURE RATING
200 W.O.G.
NON-SHOCK TO 210 F

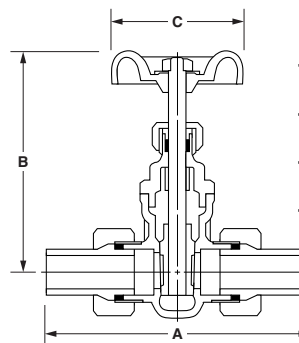

DIMENSIONS IN INCHES

VALVE SIZE	A	B	C
1/2"	5.12	3.35	1.97
3/4"	5.51	3.74	2.20

*DUPONT REG T.M.

BRONZE GLOBE VALVE

I.P.S.



**MODEL
T-421**

LEGEND MODEL T-421 bronze globe valves have a screwed bonnet, rising stem, integral seat and swivel disc for accurate throttling and flow control. The body and bonnet are constructed of heavy duty bronze. Recommended for heavy industrial use when the valve is to be operated frequently

MATERIAL SPECIFICATION	
PART	MATERIAL
BODY	BRONZE
BONNET	BRONZE
STEM	FORGED BRASS
PACKING NUT	BRASS
DISC	BRASS
HAND WHEEL	ALUMINUM
WHEEL NUT	BRASS
GLAND	BRASS
GLAND PACKING	GRAPHITE/TEFLON*

PRESSURE RATING
200 W.O.G. NON-SHOCK
125 W.S.P.

*DUPONT REG T.M.

DIMENSIONS IN INCHES

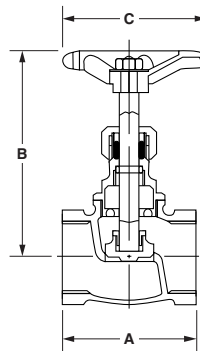

VALVE SIZE	A (I.P.S.)	B	C
1/2"	1.96	2.81	1.97
3/4"	2.18	3.27	2.21
1"	2.56	3.90	2.36
1 1/4"	2.92	4.30	3.23
1 1/2"	3.29	4.94	3.34
2"	3.90	5.95	3.94

BRASS SWING CHECK VALVE

I.P.S. AND CxX



**MODEL
T-451**

**MODEL
S-451**



LEGEND MODELS T-451/S-451 check valves are constructed of heavy duty brass. They have a screwed cap, swing type disc and integral seat. They prevent backflow while offering full flow performance with a minimum of turbulence or pressure loss. Recommended for residential and commercial applications.

DIMENSIONS IN INCHES

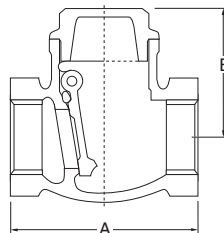

VALVE SIZE	A (I.P.S.)	A (CxX)	B
3/8"	2.01		1.40
1/2"	2.01	2.44	1.34
3/4"	2.29	3.03	1.42
1"	2.48	3.74	1.54
1 1/4"	3.15	4.37	1.89
1 1/2"	3.47	5.12	2.17
2"	3.98	5.95	2.56
2 1/2"	5.16	6.90	2.96
3"	5.79	7.60	3.82
4"	6.86		3.94

MATERIAL SPECIFICATION	
PART	MATERIAL
CAP	BRASS
BODY	BRASS
DISC	BRASS
HINGE PIN	BRASS
SCREW	BRASS

PRESSURE RATING
200 W.O.G. NON-SHOCK

BRONZE Y-PATTERN CHECK VALVE

I.P.S. AND CxC



MODEL T-453



MODEL S-453

MATERIAL SPECIFICATION	
PART	MATERIAL
CAP	BRONZE
BODY	BRONZE
DISC	BRONZE
HINGE PIN	BRASS
SCREW	BRASS

PRESSURE RATING
300 W.O.G. NON-SHOCK
150 W.S.P.

LEGEND MODELS T-453/S-453 y-pattern check valves are constructed of heavy duty bronze. They have a screwed cap, swing type disc and integral seat. The y-pattern design has excellent full flow characteristics and can be installed vertically or horizontally.

Recommended for preventing backflow in commercial and industrial applications.

DIMENSIONS IN INCHES				
VALVE SIZE	A (I.P.S.)	A (CxC)	B	
1/2"	2.19	2.56	1.67	
3/4"	2.76	3.44	2.01	
1"	3.11	4.06	2.28	
1 1/4"	3.74	4.69	2.69	
1 1/2"	4.33	5.38	3.07	
2"	5.08	6.69	3.78	

BRONZE IN-LINE CHECK VALVE

SPRING LOADED
I.P.S. AND CxC



MODEL T-455



MODEL S-455

MATERIAL SPECIFICATION		
PART	MATERIAL	
BODY	BRONZE	
END ADAPTER	BRONZE	
DISC	BUNA-N	
DISC	1/2" - 1 1/4"	FORGED BRASS
HOLDER	1 1/2" - 2"	BRONZE
SPRING	PHOSPHOR BRONZE	

PRESSURE RATING
250 W.O.G.

LEGEND MODELS T-455/S-455 spring loaded in-line check valves are constructed of heavy duty bronze. They are silent type and have Buna-N discs for quick, silent closing. They provide positive backflow prevention and minimized water hammer. They may be installed in any position. Recommended for preventing backflow in commercial and industrial applications.

DIMENSIONS IN INCHES			
VALVE SIZE	A (I.P.S.)	A (CxC)	B
1/2"	2.09	2.40	1.22
3/4"	2.32	2.80	1.50
1"	2.64	3.54	1.89
1 1/4"	3.07	3.86	2.16
1 1/2"	3.31	4.23	2.60
2"	3.78	5.08	3.14

BRONZE IN-LINE CHECK VALVE

SPRING LOADED
I.P.S.



MODEL
T-450

MATERIAL SPECIFICATION	
PART	MATERIAL
BODY	BRONZE
STOPPER	BRONZE
O-RING	NBR (Buna-N)
WASHER	NBR (Buna-N)
SPRING	STAINLESS STEEL #304
CAP	STAINLESS STEEL #304
NUT	STAINLESS STEEL #304
STEM	BRONZE

PRESSURE RATING
200 W.O.G.
200 F Maximum Service Temperature

LEGEND MODELS T-450 spring loaded in-line check valves are constructed of heavy duty bronze. They are silent type and have a NBR disc for quick, silent closing. They provide positive backflow prevention and minimized water hammer. They may be installed in any position.

DIMENSIONS IN INCHES		
VALVE SIZE	A	B
1/2"	2.72	1.38
3/4"	3.27	1.54
1"	3.39	1.87
1 1/4"	3.63	2.21
1 1/2"	4.02	2.50
2"	4.96	3.13

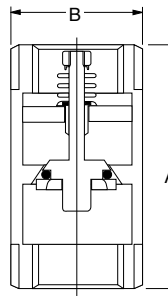

CAST IRON Y-STRAINER

I.P.S.



MODEL
T-17

MATERIAL SPECIFICATION	
PART	MATERIAL
BODY	CAST IRON
CAP	CAST IRON
SCREEN	304 STAINLESS STEEL

PRESSURE RATING
500 W.O.G. NON-SHOCK
250 W.S.P.

LEGEND MODEL T-17 y-strainers are constructed of heavy duty cast iron. They have a 20 mesh 304 stainless steel screen in sizes 1/4"-2" and a 1/16" perforated strainer in 2 1/2" and 3". The cast iron retainer cap is gasketed and tapped for a closure plug (closure plug not furnished). Install strainers upstream to protect valves, regulators, and meters, etc. from rust, pipe scale and dirt. Self cleaning can be accomplished by opening the valve or plug connected to the blow-off outlet.

DIMENSIONS IN INCHES			
VALVE SIZE	A	B	C (NPT)
1/4"	3.19	1.97	1/2"
3/8"	3.19	1.97	1/2"
1/2"	3.19	1.97	1/2"
3/4"	3.75	2.68	1/2"
1"	4.00	2.95	3/4"
1 1/4"	5.00	3.45	3/4"
1 1/2"	5.75	3.78	3/4"
2"	7.00	4.33	3/4"
2 1/2"	9.25	6.10	1"
3"	10.00	7.40	1 1/4"

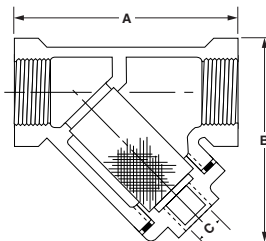

BRONZE Y-STRAINER

I.P.S. AND C x C

MODEL T-15



MODEL S-15

LEGEND MODEL T-15 and **S-15** y-strainers are constructed of heavy duty bronze. They have a 20 mesh 304 stainless steel screen in sizes 1/4"-2" and a 1/16" perforated strainer in 2 1/2" and 3". The bronze retainer cap is gasketed and tapped for a closure plug (closure plug furnished). Install strainers upstream to protect valves, regulators, and meters, etc. from rust, pipe scale and dirt. Self cleaning can be accomplished by opening the valve or plug connected to the blow-off outlet.

MATERIAL SPECIFICATION	
PART	MATERIAL
BODY	BRONZE
CAP	BRONZE
SCREEN	304 STAINLESS STEEL

PRESSURE RATING
300 W.O.G.
150 W.S.P.

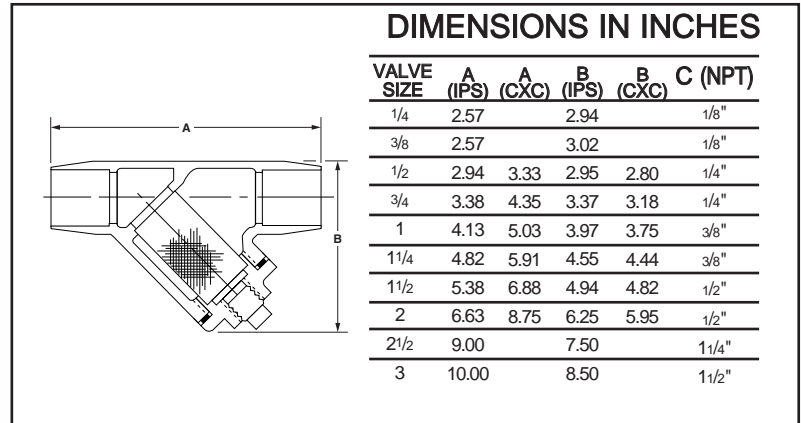

FROSTFREE SILLCOCKS

STANDARD AND WITH INTEGRAL VACUUM BREAKER

LEGEND MODELS T-551 standard frostfree sillcocks and **T-552** frostfree sillcocks with integral vacuum breaker are heavy chrome plated brass construction. The handle has an easy grip configuration and is constructed of hard plastic on the 551 and cast aluminum on the 552. The heavy brass operating worm drive provides the proper seal of washer to seat. The notched flange allows for stable installation.

MODEL T-551



MODEL T-552



MODEL T-552 IS ASSE CERTIFIED 1019 & UPC MARKED IAPMO APPROVED



The 1/2" size has combination 1/2" M.I.P. and 1/2" CxC inlet connection. The 3/4" size has combination 3/4" M.I.P. and 1/2" F.I.P. connection.

T-501

Features
 Stop valve
 125 W.O.G.
 I.P.S.
 Brass Body
 Sizes 1/2" & 3/4"



S-501

Features
 Stop valve
 125 W.O.G.
 C x C
 Brass Body
 Sizes 1/2" & 3/4"



T-521

Features
 Boiler Drain
 125 W.O.G.
 M.I.P. x G.H.T.
 Brass Body
 Sizes 1/2" & 3/4"
 1/2" has combination
 1/2" M.I.P. and 1/2" solder inlet
 connection



T-522

Features
 Boiler Drain
 125 W.O.G.
 F.I.P. x G.H.T.
 Brass Body
 Sizes 1/2" & 3/4"



T-503

Features
 Angle Stop
 125 W.O.G.
 I.P.S.
 Brass Body
 Sizes 1/2" & 3/4"



S-503

Features
 Angle Stop
 125 W.O.G.
 C x C
 Brass Body
 Sizes 1/2" & 3/4"



T-511

Features
 Stop & Waste
 125 W.O.G.
 I.P.S.
 Brass Body
 Sizes 1/2" & 3/4"



S-511

Features
 Stop & Waste
 125 W.O.G.
 C x C
 Brass Body
 Sizes 1/2" & 3/4"



T-512

Features
 Stop & Waste
 125 W.O.G.
 Compression
 ends
 Brass Body
 Sizes 1/2" & 3/4"



T-541

Features
 Sillcock
 125 W.O.G.
 F.I.P. x G.H.T.
 Brass Body
 Sizes 1/2" & 3/4"



S-541

Features
 Sillcock
 125 W.O.G.
 SWT x G.H.T.
 Brass Body
 Sizes 1/2" & 3/4"



T-541 LS

Features
 Locksheild
 Sillcock
 125 W.O.G.
 F.I.P. X G.H.T.
 Brass Body
 Sizes 1/2" & 3/4"



S-541 LS

Features
 Locksheild Sillcock
 125 W.O.G.
 SWT x G.H.T.
 Brass Body
 Sizes 1/2" & 3/4"



T-537

Features
 Hose bibb
 200 W.O.G.
 Ball valve
 M.I.P. x G.H.T.
 Brass body
 Sizes 1/2" & 3/4"
 1/2" has combination 1/2" M.I.P.
 and 1/2" solder inlet connection



T-538

Features
 Bent nose
 garden valve
 200 W.O.G.
 Ball valve
 F.I.P. x G.H.T.
 3/4" Size



LOW PRESSURE VALVES

T-531

Features

Hose bibb
125 W.O.G.
M.I.P. x G.H.T.
Brass body
Sizes 1/2" & 3/4"
1/2" has combination
1/2" M.I.P. and 1/2" solder
inlet connection



T-532

Features

Hose bibb
125 W.O.G.
Plain end
Brass body
Sizes 1/2" & 3/4"
1/2" has combination
1/2" M.I.P. and 1/2" solder
connection



T-533

Features

Hose bibb
125 W.O.G.
No kink
M.I.P. x G.H.T.
Brass body
Sizes 1/2" & 3/4"
1/2" has combination
1/2" M.I.P. and 1/2"
solder connection



T-534

Features

Hose bibb
125 W.O.G.
No kink
F.I.P. x G.H.T.
Brass body
Sizes 1/2" & 3/4"



S-535

Features

Hose bibb
125 W.O.G.
No kink
SWT x G.H.T.
Brass body
Size 1/2" & 3/4" SWT



T-543

Features

Bent nose
garden valve
125 W.O.G.
Brass body
F.I.P. x G.H.T.
Sizes 1/2" & 3/4" & 1"



T-12

Features

Washing machine
valve
125 W.O.G.
Chrome plated
Compression x
G.H.T.
Brass body
Sizes 5/8" O.D. x G.H.T.



T-523

Features

Boiler drain
125 W.O.G.
Compression x
G.H.T.
Brass body
1/2" Size



T-501X

Features

Stop valve
125 W.O.G.
I.P.S.
Cross handle
Brass body
Sizes 1/2" & 3/4"



T-502

Features

Stop valve
125 W.O.G.
CPVC transition
ends
Brass body
Sizes 1/2" & 3/4"



T-513

Features

Stop & waste
125 W.O.G.
CPVC transition
Brass body
Sizes 1/2" & 3/4"



T-504

Features

Stop valve
125 W.O.G.
Long bonnet
I.P.S.
Brass body
1/2" Size



S-504

Features

Stop valve
125 W.O.G.
Long bonnet
CxC
Brass body
1/2" Size



T-505

Features

Angle stop
125 W.O.G.
Long bonnet
I.P.S.
Brass body
1/2" Size



S-505

Features

Angle stop
125 W.O.G.
Long bonnet
CxC
Brass body
1/2" Size



COMMERCIAL SILLCOCKS

CHROME PLATED BRASS
I.P.S.



**MODEL
T-545**



**MODEL
T-546**

LEGEND MODELS T-545 and **T-546** heavy pattern commercial sillcocks are constructed of heavy duty chrome plated brass. They have a screw-over bonnet, extra large stem and packing nut. Their large wrench flats and flange allow for easy installation. Their heavy, high quality construction combined with their competitive pricing make the T-545/T-546 the finest value in their class.

MATERIAL SPECIFICATION	
PART	MATERIAL
BODY	CHROME PLATED BRASS
PACKING NUT	BRASS ROD
DISC	STAINLESS STEEL
WASHER	EPDM
** LOCKSHEILD	BRASS
** LOOSE KEY	CAST BRASS
STEM	FORGED BRASS
HANDLE	CAST ALUMINUM
SEAT SCREWS	BRASS
BONNET	CHROME PLATED BRASS
STEM PACKING	ASBESTOS FREE GRAPHITE
HANDLE SCREW	CHROME PLATED STEEL
SEAT DISC	EPDM

PRESSURE RATING
125 W.O.G.

** APPLIES TO MODEL T-546 ONLY

DIMENSIONS IN INCHES		
VALVE SIZE	A	B
1/2" T-545	4.63	3.88
3/4" T-545	4.82	3.88
1/2" T-546	4.56	4.00
3/4" T-546	4.75	4.00

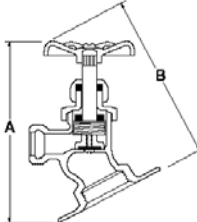

COMMERCIAL SILLCOCKS

CHROME PLATED BRASS WITH VACUUM BREAKER
I.P.S.



**MODEL
T-545VB**



**MODEL
T-546VB**

LEGEND MODELS T-545VB and **T-546VB** commercial sillcocks are the same construction as the T-545 and T-546 above except they have a non-removable chrome plated ASSE 1011 certified vacuum breaker assembled on them. The heavy, high quality construction combined with their competitive pricing make the T-545VB/T-546VB the finest value in their class.

MATERIAL SPECIFICATION	
PART	MATERIAL
BODY	CHROME PLATED BRASS
PACKING NUT	BRASS ROD
DISC	STAINLESS STEEL
WASHER	EPDM
** LOCKSHEILD	BRASS
** LOOSE KEY	CAST BRASS
STEM	FORGED BRASS
HANDLE	CAST ALUMINUM
SEAT SCREWS	BRASS
BONNET	CHROME PLATED BRASS
STEM PACKING	ASBESTOS FREE GRAPHITE
HANDLE SCREW	CHROME PLATED STEEL
SEAT DISC	EPDM

PRESSURE RATING
125 W.O.G.

** APPLIES TO MODEL T-546 ONLY

DIMENSIONS IN INCHES		
VALVE SIZE	A	B
1/2" T-545VB	4.63	3.88
3/4" T-545VB	4.81	3.88
1/2" T-546VB	4.56	4.00
3/4" T-546VB	4.75	4.00

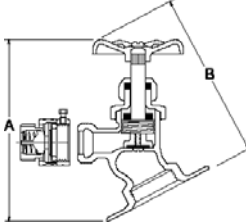

CHROME STOPS

CHROME PLATED BRASS
I.P.S., SWEAT AND COMPRESSION

MATERIAL SPECIFICATION	
PART	MATERIAL
HANDLE	ZINC
HANDLE SCREW	BRASS
PACKING NUT	BRASS
PACKING	BUNA-N
STEM	BRASS/CELCON
SEAT	BUNA-N
WASHER	STEEL
BODY	BRASS
COMP. NUT	BRASS
FERRULE	BRASS

LEGEND CHROME STOPS are made from only the finest raw materials. The bodies are deluxe chrome plated brass bar stock. The stems are brass for sweat stops and celcon for compression. Each stop is air tested twice: in the open and closed positions.

ANGLE VALVES

T-581 COMP. X COMP.

Features

110 W.O.G.
Chrome plated
brass body

Sizes:

3/8" OD x 3/8" OD
* 5/8" OD x 3/8" OD
5/8" OD x 1/2" OD



*ALSO AVAILABLE IN POLISHED BRASS

S-581 SWEAT X COMP.

Features

110 W.O.G.
Chrome plated
brass body

Sizes:

1/2" SWT x 3/8" OD
1/2" SWT x 1/2" OD



T-581 FIP X COMP.

Features

110 W.O.G.
Chrome plated
brass body

Sizes:

3/8" FIP x 3/8" OD
1/2" FIP x 3/8" OD
1/2" FIP x 1/2" OD



T-581 BARB X COMP.

Features

110 W.O.G.
Chrome plated
brass body

Sizes

1/2" BARB x 3/8" OD



T-581 CPVC X COMP.

Features

110 W.O.G.
Chrome plated
brass body

Sizes

1/2" CPVC x 3/8" OD



T/S-581 LS

Features

110 W.O.G.
Chrome plated
brass body

Lockshield

Sizes:

1/2" FIP x 3/8" OD
5/8" OD x 3/8" OD
1/2" SWT x 3/8" OD



S-581ET SWEAT X COMP.

Features

110 W.O.G.
Chrome plated
brass body
5" Extension
Bell Escutcheon

Sizes:

1/2" SWT x 3/8" OD



T-583

Features

110 W.O.G.
Chrome plated
brass body
Slipjoint

Sizes:

1/2" FIP x 1/2" or 7/16" OD
5/8" OD x 1/2" or 7/16" OD
1/2" SWT x 1/2" or 7/16" OD



STRAIGHT VALVES

T-582 COMP. X COMP.

Features

110 W.O.G.
Chrome plated
brass body

Sizes:

3/8" OD x 3/8" OD
5/8" OD x 3/8" OD
1/2" OD x 1/2" OD
5/8" OD x 1/2" OD

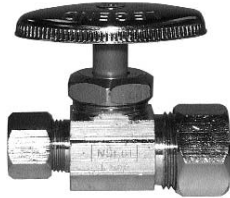

T-582 FIP X COMP.

Features

110 W.O.G.
Chrome plated
brass body

Sizes:

3/8" FIP x 3/8" OD
1/2" FIP x 3/8" OD
1/2" FIP x 1/2" OD

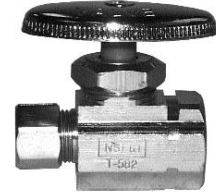

S-582 SWEAT X COMP.

Features

110 W.O.G.
Chrome plated
brass body

Sizes:

1/2" SWT x 3/8" OD
1/2" SWT x 1/2" OD



T-582 CPVC X COMP.

Features

110 W.O.G.
Chrome plated
brass body

Sizes:

1/2" CPVC x 3/8" OD

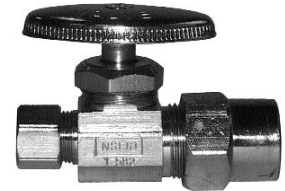

S-582ET SWEAT X COMP.

Features

110 W.O.G.
Chrome plated
brass body
5" Extension
Bell Escutcheon

Sizes:

1/2" SWT x 3/8" OD



T-584

Features

110 W.O.G.
Chrome plated
brass body
Slipjoint

Sizes:

1/2" FIP x 1/2" or 7/16" OD
5/8" OD x 1/2" or 7/16" OD
1/2" SWT x 1/2" or 7/16" OD



T-587 COMP. X COMP.

Features

110 W.O.G.
Chrome plated
brass body

Sizes:

5/8" OD x 3/8" OD x 3/8" OD
5/8" OD x 3/8" OD x 1/4" OD



T-587 FIP X COMP.

Features

110 W.O.G.
Chrome plated
brass body

Sizes:

3/8" FIP x 3/8" OD x 3/8" OD
1/2" FIP x 3/8" OD x 3/8" OD
1/2" FIP x 3/8" OD x 1/2" OD
1/2" FIP x 3/8" OD x 1/4" OD

